

Laser-UK DJ Colour II

TRI - COLOR LASER SHOW SYSTEM



Please read this manual carefully before you initially start-up!

OPEN THE BOX FOR CHECKING

Thank you for your purchase of this product DJ Colour II tri-color Laser show System.

In order to use this product safely and reasonably, please read over this manual carefully before use and the operation must strictly according to this manual to avoid any damage to the product and personal safety.

Once you receive this product, please immediately take it out carefully and check whether the product was damaged during the transportation. Then please check if the following parts are included:

DJ Colour II laser	1pc
Power cable	1pc
DMX signal cable	1pc
User manual	1pc
Wire sling	1pc

Specifications

Laser type:	Green Laser: Diode Pumped Solid Stated Laser (DPSS) Red Laser: Semiconductor Diode Laser
Laser class:	Class IIIb
Laser life:	>5000 Hours
Cooling ways:	Air-cooled.
Color:	Red@650nm Green@532nm
Laser output:	180mW (120mW@650nm 60mW@532nm)

Scanner system:	High speed optical scanner
Scan angle:	0°~±20°

Control mode:	Sound Active / Auto / DMX512
DMX channels:	10 channels

Power supply:	AC 90-240V 50/60Hz
Power consumption:	60W

Dimensions:	W268 mm xH145 mm xD318 mm
Net Weight:	<5.0Kgs

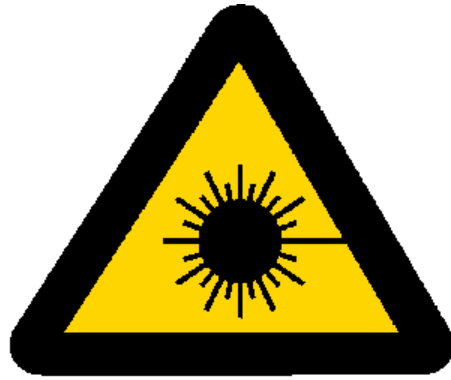

DANGER LASER RADIATION!

Avoid direct eye exposure!

Laser radiation can cause eye damage and/or skin damage

All protective measures for a safe operation of this laser must be applied.

Safety instructions

- If the device has been exposed to drastic temperature fluctuation, do not switch it on immediately. The arising condensation water might damage your device. Leave the device switched off until it has reached room temperature.
- The laser must only be used for shows. The operation is only allowed if it is controlled by a skilled and well-trained operator.
- Never leave this device running unattended and keep it away from children and amateurs.
- Keep away from heaters and other heating sources. In order to safeguard sufficient ventilation, leave 50 cm of free space around the device.
- Never direct the laser beam to people or animals.
- CAUTION LASER DIODE: Never unscrew the housing!
There are no serviceable parts inside the device. Maintenance and service operations are only to be carried out by authorized dealers.
- Always disconnect from the mains when the device is not in use or before cleaning it.
- **HEALT HAZARD! Never look directly into the light source, as sensitive persons may suffer an epileptic shock!**

Operating determinations

- The operator has to make sure that laser radiation – also reflected laser radiation – higher than the highest allowed level is avoided by technical or organizational measures.
- Make sure that the used voltage is: AC 220V~240V, 50/60Hz with ground.
- If the device is used in a flying installation, the mounting brackets and an appropriate safety-rope must be fixed.
- Laser effects are not designed for permanent operation. Consistent operation breaks will ensure that the device will serve you for a long time without defects.
- In some country, the operator must notify the accident insurance and the authority for industrial safety, before operating a laser. For more information, contact the relevant authorities.

- Please consider that unauthorized modifications on the device are forbidden due to safety reasons!
- If this device will be operated in any way different to the one described in this manual, the product may suffer damages and the guarantee becomes void.
- Furthermore, any other operation may lead to dangers like short-circuit, burns, electric shock, etc.

Product Rear View

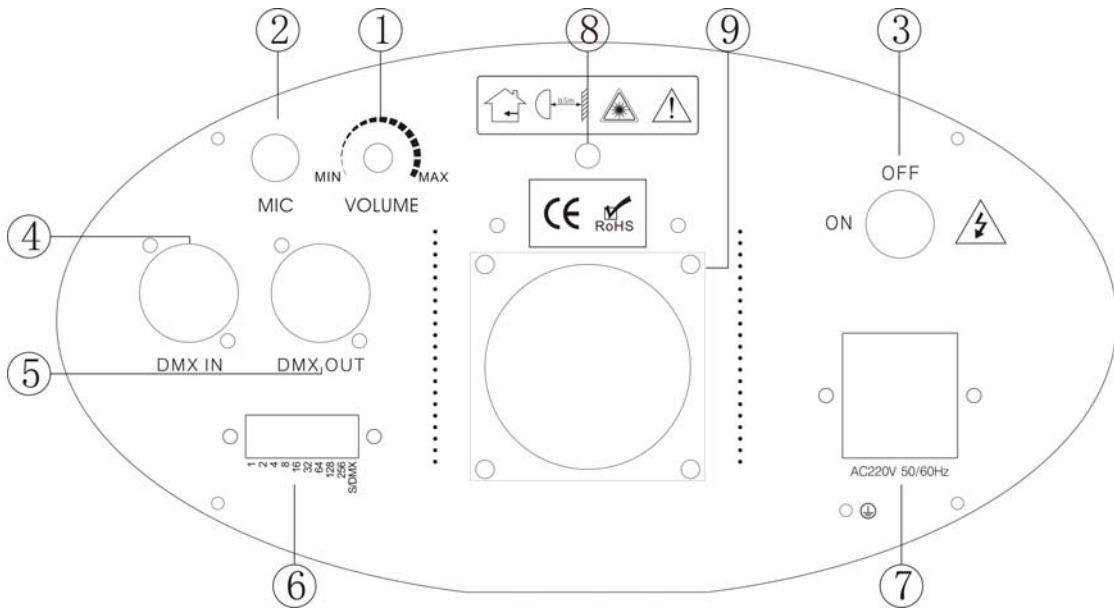

FUNCTION TABLE:



1	MIN / MAX	Music sensitivity potentiometer
2	MICROPHONE	Receive Music
3	KEY SWITCH	Power switch
4	INPUT	Signal input
5	OUTPUT	Signal output
6	ADDRESS	DMX base address
7	POWER SUPPLY	AC 220V/50-60 Hz
8	SAFE BUCKLE	Tie this device with wire sling to fixed object to avoid falling down to hurt people
9	FAN	Fan used for decreasing heat

Control mode

You can choose the control mode at the dip switches:

- When the 10th switch is OFF, 1-9 are function codes. Here the functions as follows:
 - If the first switch is OFF, the device is working in sound mode.
 - If the first switch is ON, the device is working in automatic mode.
 - For master/slave mode, put the second switch in ON position and it is the Slave device.

Function code setting

Function	Dip Switches
Sound mode	
Auto Mode	
Slave mode	

DMX mode function switch

Synchronized Connections and Settings

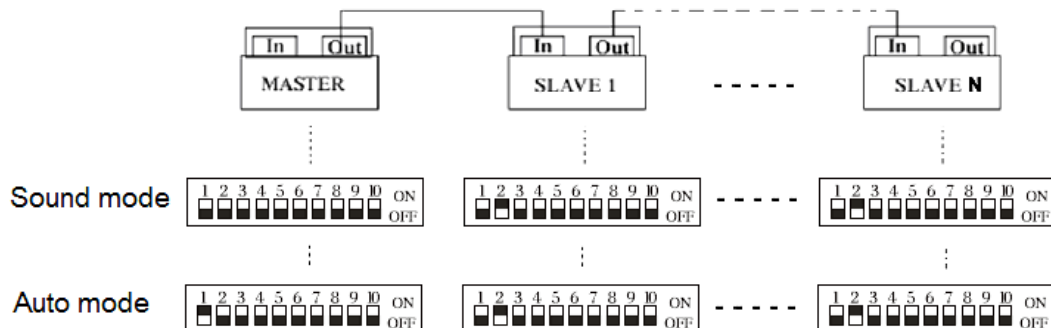





- For DMX mode, the 10th dip switch must be ON. Then, switch 1-9 can be used for adjusting the DMX base address.

DMX control

Set the DMX base address with the binary system “0” or “1” and remind that the 10th Dip switch is ON for DMX mode.

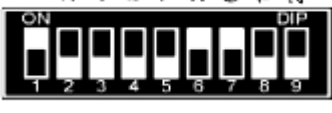
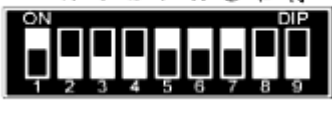
Examples:

DMX address		DMX address	
1		33	
65		113	
161		225	

The device has 19 operating channels. If you set the first on DMX address “1”, the next DMX device can follow at address 20.

DMX channels:

CHANNEL	DMX512 VALUE	FUNCTION
1.Control Mode	0-63	Sound Active mode- only channel2 is available
	64~127	Auto run mode- only channel2 is available
	128~255	Manual – all other channels are available
2. unused		reserved
3.pattern	0~255	63 patterns: $(0-252)/4=(0-62)$ 252~255: blank

4.speed	0~255	12 grade speed(0~255)/23=(0~11)
5. Horizontal & vertical roll	0-63	No Function.
	64~127	Horizontal roll
	128 ~191	Vertical roll
	192~ 255	Horizontal & vertical roll
6.Rotation&Point-Draw	0-63	No Function.
	64~127	Rotation
	128 ~191	Point-Draw(only point)
	192~ 255	Rotation&Point-Draw
7.Horizontal & vertical move	0-63	No Function.
	64~127	Horizontal move
	128 ~191	vertical move
	192~ 255	Horizontal & vertical move
8. Horizontal & vertical stretch	0-63	No Function.
	64~127	Horizontal stretch
	128 ~191	vertical stretch
	192~ 255	Horizontal & vertical stretch
9.Small to Large &Large to Small	0~ 85	No Function.
	86 ~169	Zoom from one point to large
	170~ 255	Zoom from large to one point
10.Slow-draw speed	0~255	13 levels of speed

Remark: Product design & subject to change without further notice.

Please note: The artificial damage or maintains the label to tear, not in maintenance scope!

